



(en) Electric current! Danger to life!

Only skilled or instructed persons may carry out the following operations.

(de)

Lebensgefahr durch elektrischen Strom!

Nur Elektrofachkräfte und elektrotechnisch unterwiesene Personen dürfen die im Folgenden beschriebenen Arbeiten ausführen.

(fr)

Tension électrique dangereuse !

Seules les personnes qualifiées et averties doivent exécuter les travaux ci-après.

(es)

¡Corriente eléctrica! ¡Peligro de muerte!

El trabajo a continuación descrito debe ser realizado por personas cualificadas y advertidas.

(it)

Tensione elettrica: Pericolo di morte!

Solo persone abilitate e qualificate possono eseguire le operazioni di seguito riportate.

(zh)

触电危险!

只允许专业人员和受过专业训练的人员进行下列工作。

(ru)

Электрический ток! Опасно для жизни!

Только специалисты или проинструктированные лица могут выполнять следующие операции.

(nl)

Levensgevaar door elektrische stroom!

Uitsluitend deskundigen in elektriciteit en elektrotechnisch geïnstrueerde personen is het toegestaan, de navolgend beschreven werkzaamheden uit te voeren.

(da)

Livsfare på grund af elektrisk strøm!

Kun uddannede el-installatører og personer der er instruerede i elektrotekniske arbejdsopgaver, må udføre de nedenfor anførte arbejder.

(el)

Προσοχή, κίνδυνος ηλεκτροπληξίας!

Οι εργασίες που αναφέρονται στη συνέχεια θα πρέπει να εκτελούνται μόνο από ηλεκτρολόγους και ηλεκτροτεχνίτες.

(pt)

Perigo de vida devido a corrente eléctrica!

Apenas electricistas e pessoas com formação electotécnica podem executar os trabalhos que a seguir se descrevem.

(sv)

Livsfara genom elektrisk ström!

Endast utbildade elektriker och personer som undervisats i elektroteknik får utföra de arbeten som beskrivs nedan.

(fi)

Hengenvaarallinen jännite!

Vain pätevät sähköasentajat ja opastusta saaneet henkilöt saavat suorittaa seuraavat työt.

(cs)

Nebezpečí úrazu elektrickým proudem!

Níže uvedené práce smějí provádět pouze osoby s elektrotechnickým vzděláním.

(et)

Eluohutlik! Elektrilöögioht!

Järgnevalt kirjeldatud töid tohib teostada ainult elektriala spetsialist või elektrotehnilise instrueerimise läbinud personal.

(hu)

Életveszély az elektromos áram révén!

Csak elektromos szakemberek és elektrotechnikában képzett személyek végezhetik el a következőkben leírt munkákat.

(lv)

Elektriskā strāva apdraud dzīvību!

Tālāk aprakstītos darbus drīkst veikt tikai elektrospeciālisti un darbam ar elektrotehnikām iekārtām instruetās personas!

(lt)

Pavojus gyvybei dėl elektros srovės!

Tik elektrikai ir elektrotechnikos specialistai gali atlikti žemiau aprašytus darbus.

(pl)

Porażenie prądem elektrycznym stanowi zagrożenie dla życia!

Opisane poniżej prace mogą przeprowadzać tylko wykwalifikowani elektrycy oraz osoby odpowiednio poinstruowane w zakresie elektrotechniki.

(sl)

Življenjska nevarnost zaradi električnega toka!

Spodaj opisana dela smejo izvajati samo elektrostrokovnjaki in elektrotehnično poučene osebe.

(sk)

Nebezpečnosť ohrozenia života elektrickým prúdom!

Práce, ktoré sú nižšie opísané, smú vykonávať iba elektrooborníci a osoby s elektrotechnickým vzdelaním.

(bg)

Опасност за живота от електрически ток!

Операциите, описани в следващите раздели, могат да се извършват само от специалисти-електротехници и инструктиран електротехнически персонал.

(ro)

Atenție! Pericol electric!

Toate lucrările descrise trebuie efectuate numai de personal de specialitate calificat și de persoane cu cunoaștere profundă în electrotehnică.

(hr)

Opasnost po život uslijed električne struje!

Radove opisane u nastavku smiju obavljati samo stručni električari i osobe koje su prošle elektrotehničku obuku.

RMQ-Titan®

M22-..., M22S-..., M22M-... (M22...-...)

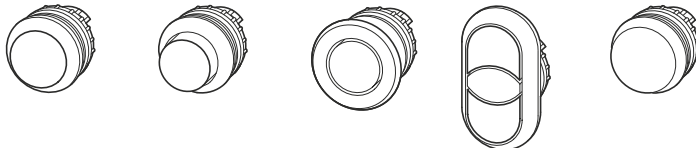

**M22-(C)LED(C)...
M22-(C)K(C)...**

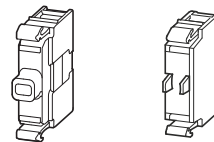

0.4 x 2.5
0.6 x 3.5
0.8 x 5.5

**M22-FLED...
M22-FK...**

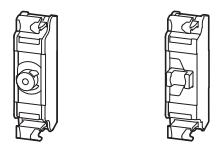

PH(PZ) 0
PH(PZ) 1
PH(PZ) 2

0.4 x 2.5
0.4 x 3.0

(en) Available colors
(de) Farbmöglichkeiten
(fr) Couleur
(es) Opciones de color
(it) Colori disponibili

(zh) 颜色种类
(ru) Возможная цветовая маркировка
(nl) Kleurmogelijkheden
(da) farvemuligheder
(el) Χρωματικές παραλλαγές

(pt) Possibilidades de cores
(sv) Färgalternativ
(fi) Värimahdollisuudet
(cs) Možnosti barev
(et) Värvivõimalused

(hu) Lehetséges színek
(lv) iespējamās krāsas
(lt) Galimos spalvos
(pl) Wersje kolorystyczne
(sl) Barvne možnosti

(sk) Možnosti farieb
(bg) Опции за цвятове
(ro) Culori disponibile
(hr) Opcije boja

M22-FLED-RG(B)

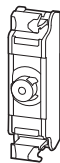

24 V DC

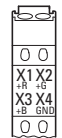
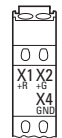

X1 +R

X2 +G

X3 +B

X4 GND

M22-FLED-RG(B)	①	✓			✓
M22-FLED-RG(B)	②		✓		✓
M22-FLED-RG(B)	③	✓	✓		✓
M22-FLED-RGB	④	✓	✓	✓	✓
M22-FLED-RGB	⑤			✓	✓
M22-FLED-RGB	⑥	✓		✓	✓
M22-FLED-RGB	⑦		✓	✓	✓

→ DIN IEC 304, DIN IEC 60 757

①	RD	2
②	GN	5
③	YE	4
④	WH	9
⑤	BU	6
⑥	VT	7
⑦	TQ	55

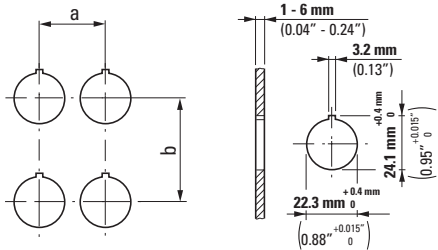

	a ≥ [mm]	b ≥	a ≥ [in]	b ≥
M22-(S)-...	30	50	1.18	1.97
(IEC/EN 60947)	30	40	1.18	1.57
M22...-D...+	33	40	1.29	1.57
M22-T-D				
M22...-D(R)(P)...	38	40	1.49	1.57
M22-PV(L) + M22-PL-PV	48	56	1.89	2.20
M22-PV(L)(S...)+ M22...-D...	33	40	1.29	1.57
M22...-DD...	30	55	1.18	55
M22...-DD... + M22-T-DD	33	58	1.29	58
M22-ST...	30	50	1.18	1.97
M22-STDD...	30	75	1.18	75
M22-CK...	30	45	1.18	45
M22-CLED...	30	45	1.18	45
M22-XAK...	90	90	3.54	3.54
M22-XZK	33	52	1.29	2.05
M22-XBK...	60	60	2.36	2.36
M22-XYK...	50	50	1.97	1.97
M22-CK11, 02, 20	30	50	1.18	1.97

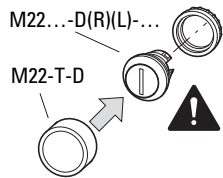

M22S-ST-...

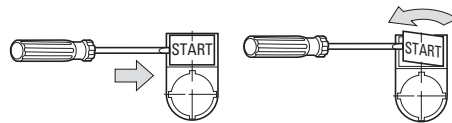

M22S-R30

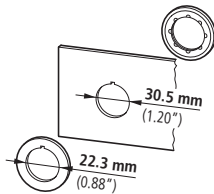

M22...-D(R, H, P)-... M22...-D(R)(L)(H)-...

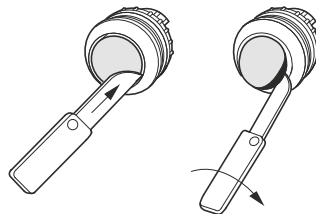

M22...-DR...

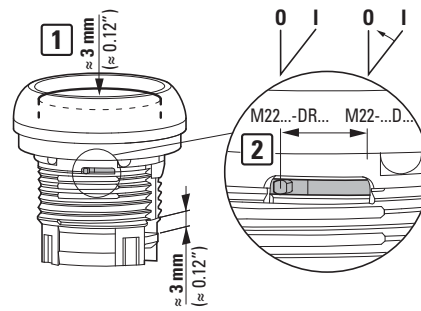

M22-L(H)-...

M22...-D(R)(L)(H)-...	-R	-R	-R
M22...-W(R)(L)(K)-...	-G	-G	-G
	-W	-W	-W
	-Y	-W	-W
	-B	-W, -B	-W, -B
	-W	-RG(B)	-RG(B)

M22-LED... M22-FLED...

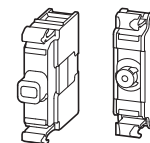

Environmental Ratings for M22... Operators

Operator Part Numbers	UL/NEMA	IEC
M22...-...	4 X, 13	IP66
M22-ST...		(IP67)
M22-XAK...		
M22-XZK...		
M22-XKB1		
M22-XYK1		
M22...-DD...	3 R, 12	IP66
M22-AMC		IP40

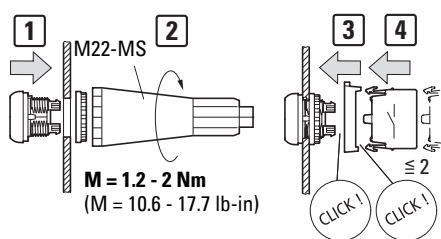

M22-TC M22-TA

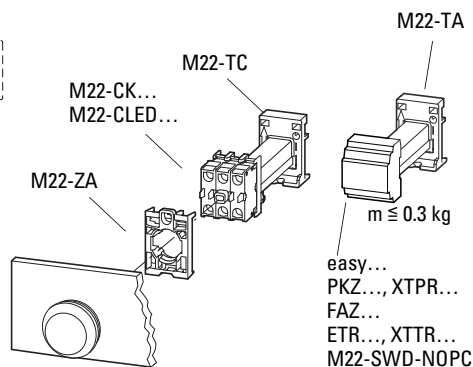

M22-K... M22-LED..., f ~ = 50 - 60 Hz

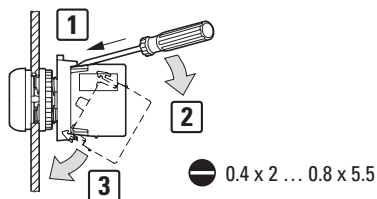

8 mm (0.31")	M ≤ 0.8 Nm M ≤ 7.1 lb-in	
	2 x 0.75 - 2.5 mm ²	AWG18 - AWG14
	2 x 0.75 - 2.5 mm ²	AWG18 - AWG14
	2 x 0.5 - 1.5 mm ²	AWG20 - AWG16

→ 60/75 °C Cu wire only

M22-IVS

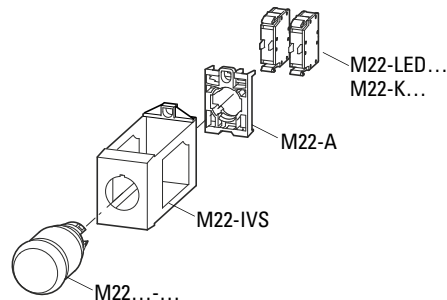

M22-CK10, 01 M22-CLED..., f ~ = 50 - 60 Hz

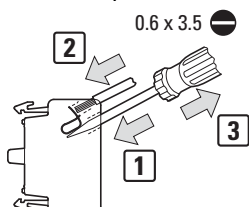

M22-CK11, 02, 20 → 5/7

M22...-W(R)...



M22...-W(R)K...



M22...-W(R)S...

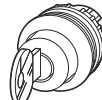

M22-XC...

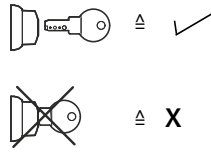
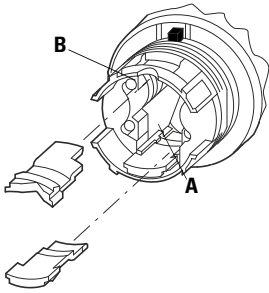

	0	I	0	I
0	0	I	0	I
60°	✓	-	✓	✓
50°	✓	✓	X	X
40°	✓	✓	X	X

	0	I	0	I
60°	60°	-	✓	✓
50°	50°	X	✓	X
60°	50°	-	✓	X
50°	60°	X	✓	✓
40°	40°	X	✓	X
60°	40°	-	✓	X
50°	40°	X	✓	X
40°	60°	X	✓	✓
40°	50°	X	✓	X

M22...-W...3-...
M22-XW

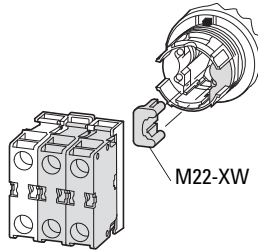
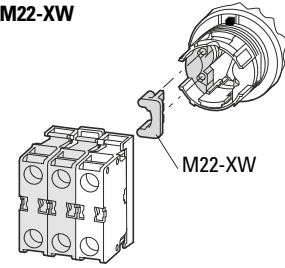

M22...-DD(L)-... + M22-T-DD

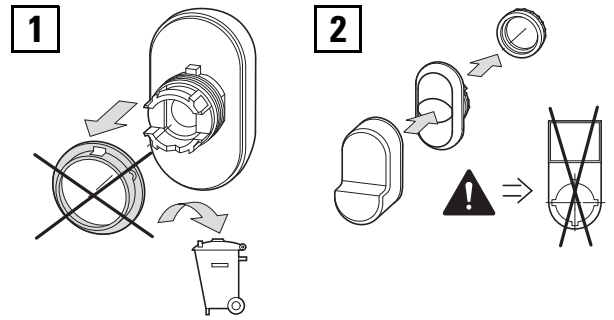

05/18 IL04716002Z

M22...-PV...

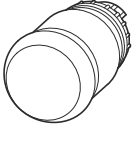

M22(S)-PV

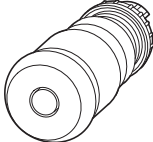

M22-PVL

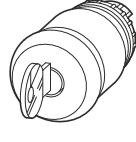

M22-PVS



M22-PV(L)T

M22S-ST-X

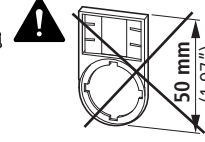

M22-XZK...
M22-XYK...

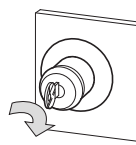
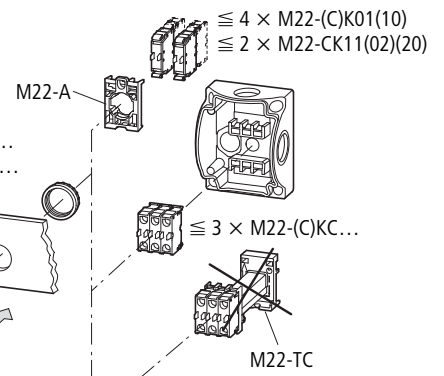

1 M22-PL-PV

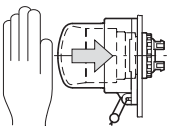

2

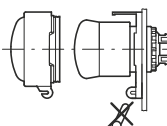

3

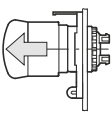

4

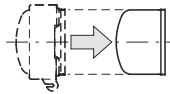

5

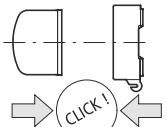

6

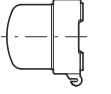

7

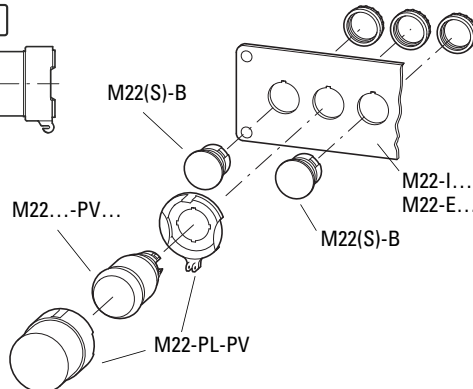
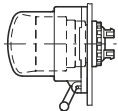

M22-AMC
M22-LC(H)

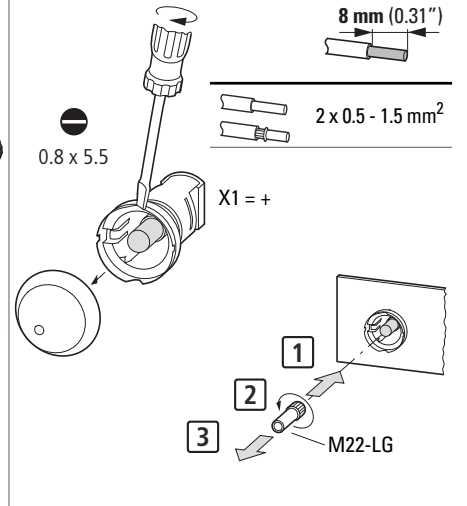

M22...-WR4

M22...-W(R)J(S)(2V)(2H)(4)(-2P)-(...BVP)

M22...-WR(K)4

M22...-D4...

M22-XCK

M22-A4

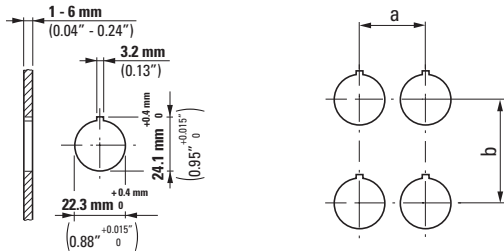
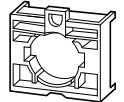
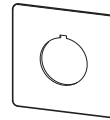
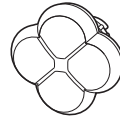

	a ≥ [mm]	b ≥ [mm]	a ≥ [in]	b ≥ [in]
M22...-WR4	45	50	1.77	1.97
M22...-W(R)J4				
M22...-W(R)K4				
M22...-D4-...	55	55	2.17	2.17
M22-XCK...	50	50	1.97	1.97

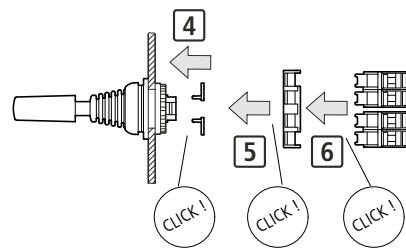
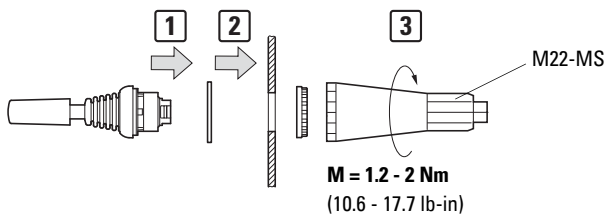

05/18 IL04716002Z

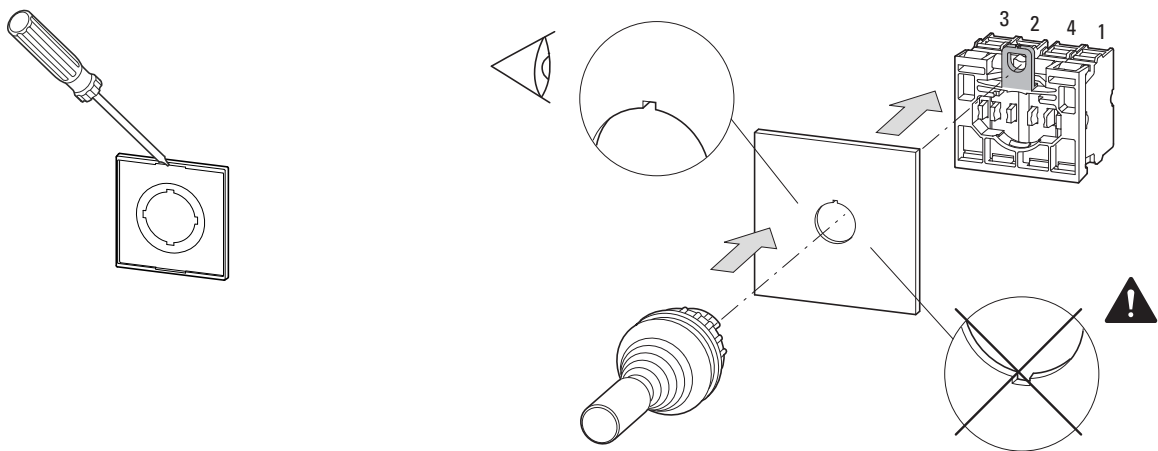
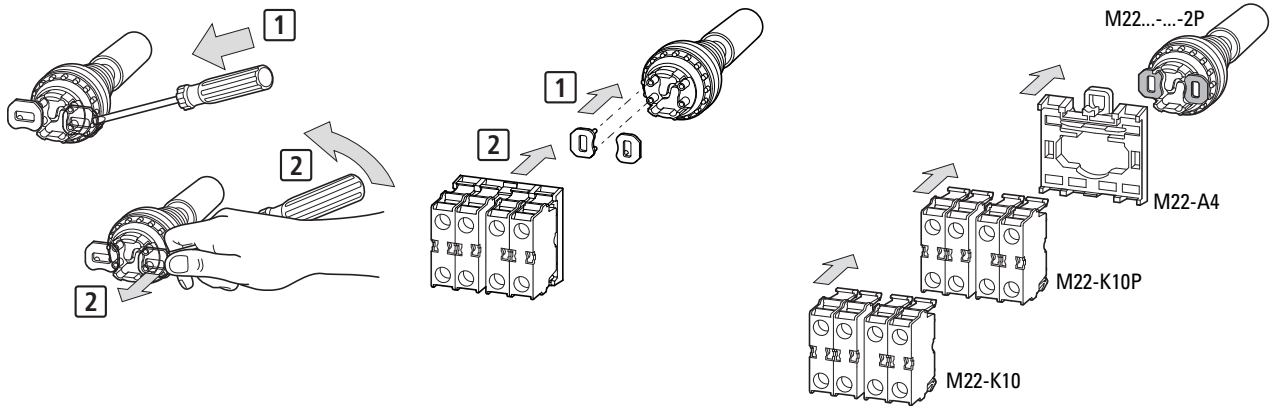

M22...-WR4
M22...-WR(K)4

M22...-W(R)J(S)(2V)(2H)(4)(-2P)-(...BVP)
M22...-D4...

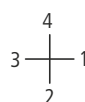

M22-CK11, 02, 20

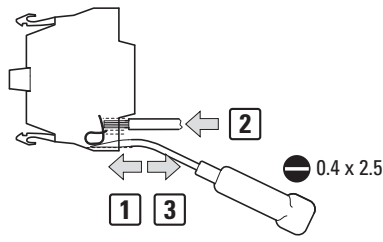
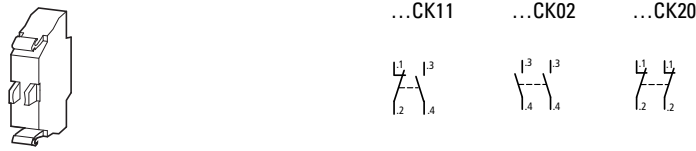

8 mm (0.31")		2 x 0.5 - 1.5 mm ²	AWG20 - AWG16
		2 x 0.5 - 1.5 mm ²	AWG20 - AWG16
		2 x 0.5 - 1 mm ²	AWG20 - AWG18

→ 60/75 °C Cu wire only

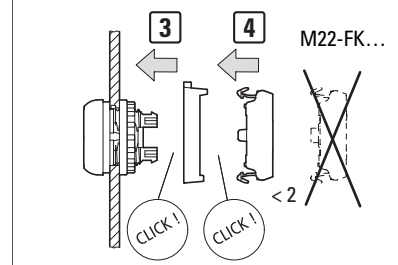
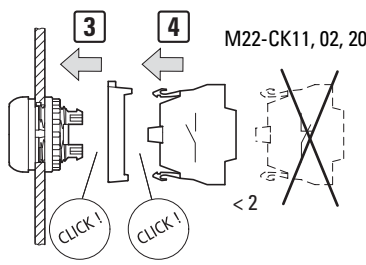
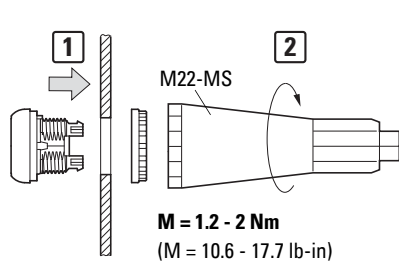
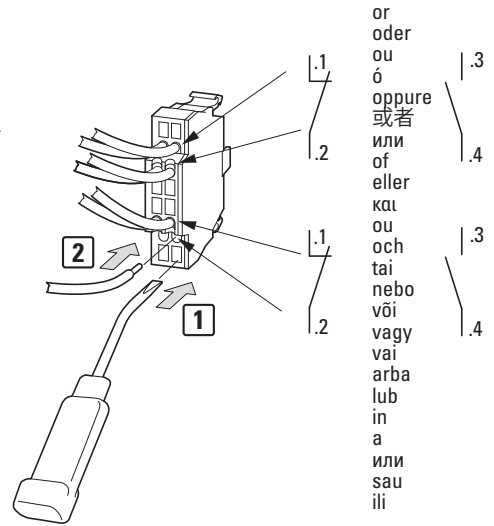

M22-CK11, 02, 20 → ~~M22-ABC(4)~~

en Reference numbers	it Numeri di riferimento	da Ordenstal	fi Järjestysluvut	lv Kārtas skaitļi	sk Poradové čísla
de Ordnungsziffern	zh 参考编号	el Αριθμοί σειράς	cs Pořadová čísla	lt Eilės numeriai	bg Поредни цифри
fr Chiffres	ru Справочные номер	pt Números de ordem	et Korraldusarvud	pl Liczby porządkowe	ro Cifre de ordine
es Números de referencia	nl Rangnummer	sv Ordningssiffror	hu Hivatkozási számok	sl Vrtilne številke	hr Kontrolni brojevi

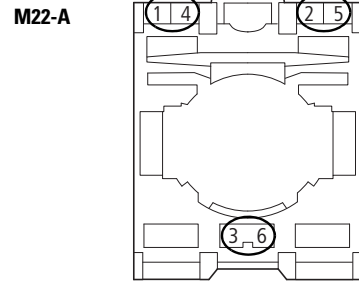
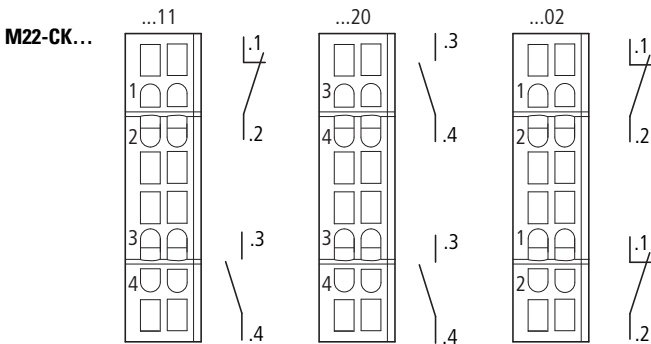

en Example	es Ejemplo	ru Пример	el Παράδειγμα	fi Esimerkki	hu Példa	pl Przykład	bg Пример
de Beispiel	it Esempio	nl Voorbeeld	pt Exemplo	cs Příklad	lv Piemērs	sl Primer	ro Exemplu
fr Exemple	zh 举例	da Eksempel	sv Exempel	et Näide	lt Pavyzdys	sk Příklad	hr Primjer

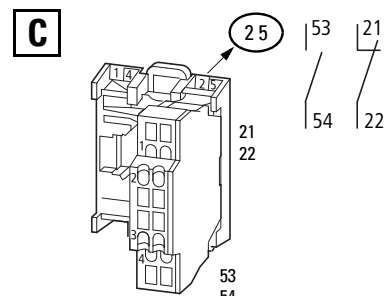
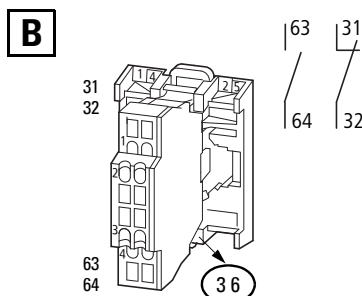
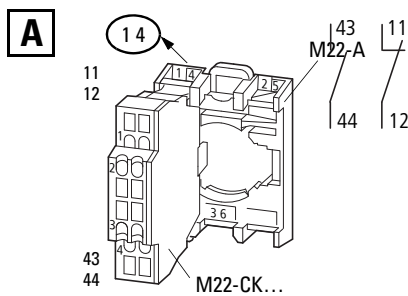

M22-A → 1 } 11, 12
M22-CK → 1, 2 }

M22-A → 4 } 43, 44
M22-CK → 3, 4 }

M22-FK...
M22-FLED...

0.4 x 2 ... 0.8 x 5.5

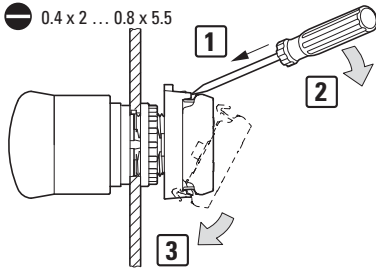

A

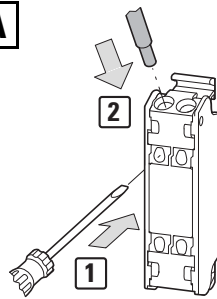

B

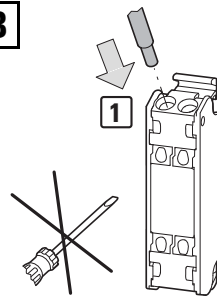

C

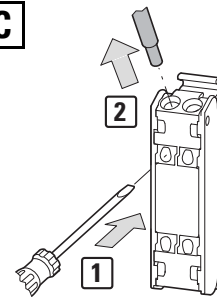

8 mm (0.31")

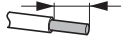

	0.25 - 0.34 mm ²	AWG24 - AWG22	A	C		
	0.5 - 1.5 mm ²	AWG21 - AWG16	B	C		
	0.2 - 1.5 mm ²	AWG24 - AWG16	A	C		
DIN 46228 T1/T4	0.25 - 0.75 mm ²	AWG24 - AWG19	A	C		
	1.0 mm ²	AWG18	B	C		

→ 60/75 °C Cu wire only

WAGO 206-204 Crimpzange Variocrimp 4

Rennsteig Article no. 6101853

Knipex 975304

Rennsteig Article no. 6101866

Knipex 975314

-
- (en) Do not use pre-assembled cables.
 - (de) Keine vorkonfektionierten Leitungen verwenden.
 - (fr) Ne pas utiliser de câbles pré-assemblés.
 - (es) No utilizar cables preconfeccionados.
 - (it) Non utilizzare cavi preconfezionati.
 - (zh) 未使用预先捆绑好的线缆。
 - (ru) Не использовать предварительно комплектованные провода.
 - (nl) Gebruik geen prefab-kabels.
 - (da) Anvend ingen fortilpassede ledninger.
 - (el) Μην χρησιμοποιείτε εκ των προτέρων συναρμολογημένους αγωγούς.
 - (pt) Não usar fios pré-confeccionados.
 - (sv) Använd inte färdigbestyckade kablar.

-
- (fi) Älä käytä esivalmisteltuja johtoja.
 - (cs) Nepoužívejte prefabrikovaná vedení.
 - (et) Ärge kasutage eelpaigaldatud juhtmeid.
 - (hu) Ne használjon előre konfekcionált vezetéket.
 - (lv) Neizmantojiet iepriekš sērīveidā ražotus vadus.
 - (lt) Nenaudokite iš anksto paruoštų laidų.
 - (pl) Nie używać przewodów wstępnie zmontowanych.
 - (sl) Ne uporabljajte predhodno konfencioniranih vodnikov.
 - (sk) Nepoužívajte prefabrikované vedenia.
 - (bg) Да не се използват предварително монтирани кабели.
 - (ro) Nu utilizați cabluri preconfeccionate.
 - (hr) Nemojte upotrebljavati unaprijed sastavljene vodove.

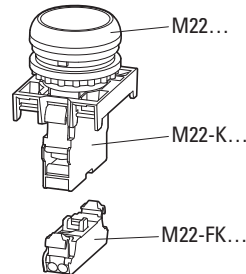
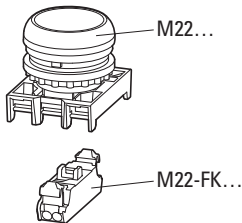

	M22-FK10	M22-FK01
D(R)(L)(H)	✓	✓
D(I)4	✓	✓
DG(L)	✓	✓
D(R)(L) (P)	✓	✓
D(L)VHS	✓	✓
DD(L)(F)(M)	✓	✓
W(R)(L)(K)(3)	✓	✓
W(R)(L)(K)(V)	✓	✓
W(R)(S)(3)	✓	✓
W(R)(J)(2)(4)(V)(H)	✓	✓
WR(K)4	✓	✓
PV(L)(T)	✓	✓
PV(L)(T)45P	✓	✓
PV(L)(T)60P	✓	✓
PVS(45) (60)(P)	✓	✓

	M22-(C)K01/(C)K10 + M22-FK10	M22-(C)K01/(C)K10 + M22-FK01	M22-(C)K10P + M22-FK10	M22-(C)K10P + M22-FK01
D(H)	✓	✓	✓	✓
DR(H)	-	✓	-	✓
D(I)4	✓	✓	✓	✓
DL(H)	✓	✓	✓	✓
DRL(H)	-	✓	-	✓
D(L)VHS	✓	✓	✓	✓
DG(L)	✓	✓	✓	✓
DD(L)(F)(M)	✓	✓	✓	✓
D(R)P	✓	✓	✓	✓
W(R)(L)(K)(3)	✓	✓	✓	✓
WR(K)4	-	✓	-	✓
W(R)(L)(K)(V)	✓	✓	✓	✓
W(R)(S)(3)	✓	✓	✓	✓
W(R)(J)(2)(4)(V)(H)	✓	✓	✓	✓
PV(L)(T)	✓	✓	✓	✓
PV(L)(T)45P	✓	✓	✓	✓
PV(L)(T)60P	✓	✓	✓	✓
PVS(45) (60)(P)	✓	✓	✓	✓

